

# BADGER

# Anthem™

## MODEL 155™

### INSTRUCTION BOOK



U.S. Patent #5,779,157

# AIR-BRUSH



**SPECIAL NOTE:** Read instructions for proper care in handling and operation. Use in well ventilated area. Always read and follow instructions, cautions, and warnings on materials being sprayed. See back page for further information.

At BADGER AIR-BRUSH CO. we are extremely proud of our people and our products. Our continued growth and success is based upon high quality and conscientious craftsmanship in the manufacture of each and every BADGER product. At BADGER AIR-BRUSH CO. there is a feeling of accomplished pride and dedication to *you*, the BADGER airbrush user, that bonds the entire BADGER family, and goes into the design, development, and manufacture of every airbrush we make.

Each airbrush and all of its components are carefully machined, inspected, assembled by hand, and **tested in actual use to be certain it meets BADGER'S and your high standards of quality.** Then, and only then, the BADGER name is put on it.

This dedication to excellence and commitment to your satisfaction prompts us to stand behind all of our products and offer the following warranty.

#### WARRANTY

Your BADGER airbrush is warranted against all manufacturing defects of material and/or factory workmanship origin for a period of one year. Any part or material that becomes defective or is worn so as to not be usable within one year of purchase will be **repaired or replaced** at our discretion and expense. **Your BADGER airbrush has a lifetime warranty for any necessary factory labor** (After the first year, the only cost of factory repair will be the cost of shipping to the factory and repair related parts). These warranties do not cover damage caused by negligence, accidents, misuse, or units that have been abused or altered in any way. The PTFE needle bearing has a lifetime warranty and if ever necessary will be replaced at the factory without cost, except for to the factory shipment cost, to the airbrush owner.

**CONGRATULATIONS** on your purchase of the Model 155™ **Anthem™**, a superior quality-precision crafted airbrush designed, engineered, and manufactured by BADGER AIR-BRUSH CO. The Model 155™ is possibly the most versatile airbrush available to date. It has a single-size paint tip, spray regulator, and needle that work with any properly reduced medium, including acrylics, gouache, inks & dyes, enamels, lacquers, stains, etc. The **Anthem™** works especially well with BADGER Air-Opaque™, Air-Text™, Totally Tattoo™, Freakflex™ and MODELflex™ paints.

The Model 155™ is suitable for many applications, including fine art & illustration, T-shirt & fabric painting, sign painting, automotive graphics, model painting & detailing, taxidermy, a wide variety of craft & decorative painting applications, etc.

#### READ INSTRUCTIONS CAREFULLY BEFORE OPERATING

##### TO OPERATE

- 1) Attach hose to air supply (compressor, aerosol propellant can, or CO<sub>2</sub> tank). A compressor or CO<sub>2</sub> tank is more suitable for larger jobs or prolonged spraying. Holding air hose in hand, attach airbrush to air hose, at hose end opposite air source, by gently turning in clockwise motion onto fitting. **Finger** tighten air hose snugly onto airbrush.
- 2) Air pressure should be set between 15 to 50 p.s.i. The most efficient operating pressure for air brushing is approximately 30 p.s.i. BADGER offers an air regulator w/pressure gauge (50-054) that can be connected to any compressor to allow for proper air pressure setting. BADGER also recommends and offers a moisture trap (50-051) for usage when airbrushing in high humidity environments.
- 3) Attach jar or color cup, containing material to be sprayed, to the airbrush. Attach by inserting stem of jar adapter or color cup into the jar connector tube located on the bottom front of the airbrush body. Give the stem a slight counter clockwise turn to snug the jar/color cup securely into place. To remove jar/color cup when finished pull down and rotate in a clockwise direction.  
Once your air source is on, and your airbrush is properly connected and set up, you are ready to begin airbrushing.
- 4) To begin operation of the airbrush depress the trigger. This will generate air flow through the airbrush. Then, by drawing back on the trigger, paint (or whatever material is being sprayed) will be released. The further the trigger is pulled back the larger the amount of paint that will be sprayed. The size of line the airbrush will create is determined by the amount of paint being sprayed (how far the trigger is being pulled back) and at what distance the airbrush is being held from the surface being sprayed

onto. A fine line or small dot is achieved by working very close to the surface while releasing a very small amount of paint. A broad spray pattern is achieved by moving the airbrush back from the work surface and pulling back further on the trigger to release a larger amount of paint. The proper mechanics for triggering the airbrush are – press down to start air flow, pull back to begin and increase paint flow, push forward to lessen or stop paint flow, release (or up) to stop air flow.

## LEARN TO TRIGGER

Best results are achieved with the **Anthem™** by airbrushing with a good constant motion. Start motion before pressing trigger, follow through motion after releasing trigger. Do not hesitate while spraying or you will create what is called the Barbell Effect.

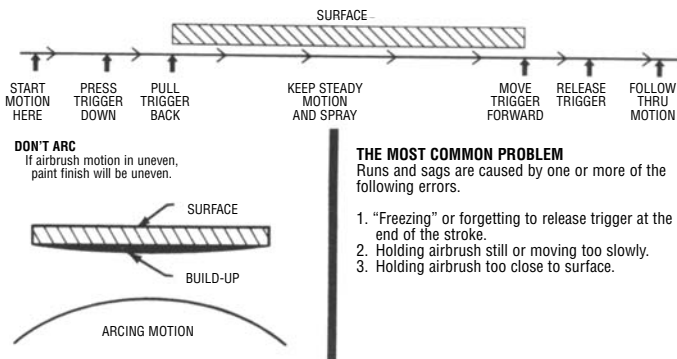

## MAINTENANCE AND CLEANING OF YOUR AIRBRUSH

Careful cleaning and maintenance of your airbrush is essential if it is to continue to work effectively. The small passages inside the airbrush can become blocked easily by dried paint if the airbrush is not cleaned after each use. If there is still a useable amount of color in the color cup or reservoir when you have finished spraying, pour the remainder back into the original paint bottle. Operate the airbrush, spraying on a scrap piece of paper until the color is gone and only air is sprayed. Take a clean color cup or jar full of appropriate cleaner. Insert it into the airbrush, spray some cleaner through the airbrush at broad and small patterns until it comes out colorless. After removing color cup or jar, turn the airbrush upside down and press trigger. This will remove any material still in the airbrush. Always clean the airbrush every time you finish spraying as some types of paint can dry remarkably fast, and may cause your airbrush to clog if not cleaned properly.

Another method of cleaning the airbrush is back flushing using a closed container such as a jar assembly. Take a soft cloth and cover the spray regulator – depress and pull back on the trigger. This will cause back pressure which induces a bubble action inside the airbrush and in the container which helps to clean the fluid passages. Never use an open color cup for this procedure as color will blow out. Take away the cloth and spray and repeat this procedure several times. After this is done you should remove the needle for cleaning.

If the paint is allowed to dry inside the airbrush you may not be able to dissolve it with clean water. Cleaning with solvent is the next step. If cleaning with solvent does not dissolve the blockage, you will have to disassemble the airbrush, by first removing the needle and then the head. Soak the tip in warm soapy water or appropriate solvent for ten minutes. Then take a tooth pick and gently remove the dried paint from inside the fluid tip. This procedure may have to be repeated. Be careful during disassembly not to lose any small parts.

## REMOVING & REPLACING THE TIP

When replacing the paint tip (41-004), it is important to loosen the needle chuck (50-010) and partially retract the needle (51-048). This will ensure that no damage will occur to the tip or needle as the head assembly is tightened.

Unscrew the Spray Regulator (41-034), and Head (51-071). The tip can now be removed from its tapered seat in the airbrush body (51-069). Make sure there is no dried paint on any part of the airbrush head or body that could interfere with proper tip seating. Even a small amount of dried paint can cause tip misalignment, which could lead to an uneven or pulsating spray pattern. Dried paint can be removed using a moist cotton swab.



Place the new tip into its seat in the airbrush body (see photograph 1), and then screw the head and spray regulator onto the airbrush body. The head assembly on the Model 155™ is designed to be tightened firmly by hand – *use of pliers or other tools should not be necessary!*

Before spraying, reseat the needle into the new tip by pushing the needle forward until it stops. Do not push forcefully or the tip could split at the end. The Needle Chuck should then be re-tightened.

**MANUFACTURER'S NOTE:** Although the nozzle and needle assemblies of this airbrush are manufactured to easier maintenance “finger tight” tolerances the initial removal of some components may require the use of a small pliers. If a pliers is necessary for initial component disassembly, just finger tighten it when reassembling and the pliers should not be required for assembly/disassembly thereafter.

## REMOVING & REPLACING THE NEEDLE

The Model 155™ is designed so that the needle can be removed *without removing the handle*. The Needle Chuck can be loosened through the openings in the cut-away handle (51-075), (see photograph 2) which will permit the needle to be removed by pulling it straight back. If the needle sticks, try turning the needle as you pull back. If this proves unsuccessful, grip the knob on the end of the needle with pliers and apply a twisting force to free the needle. Be careful when using this method to avoid damage to the airbrush.



Before installing a needle, check for hardened paint on the needle. This can be cleaned off of the needle by holding the needle flat on a tabletop and rubbing a pink eraser along the length of the needle until all paint residue is removed. Use your thumb and forefinger to remove any eraser particles.

A bent needle may need to be replaced. If the needle has a tiny “hook” at the point, you might be able to straighten it out by placing the needle on a firm surface so that the tapered part of the needle is flat against the surface. Run your fingernail across the tip as you rotate the needle. Always drag your fingernail towards the point of the needle.

## TRIGGER TENSION

Your Model 155™ airbrush has been set with maximum trigger tension which should be suitable for most users. If less return spring back pressure is desired, the spring screw (50-031) can be *partially* unscrewed to lessen the spring pressure. Do not unscrew the entire tube shank (50-030) assembly to release pressure on the Model 155™. If the tube shank is not seated firmly in the body of the airbrush, it may spin when trying to loosen the needle chuck through the openings in the cut-away handle.

## REMOVING THE TUBE SHANK & TRIGGER COMPONENTS

Before removing the handle to remove or adjust any of the tube shank components, the needle must be removed by loosening the needle chuck through the openings in the cut-away handle and drawing the needle out from the rear.



The tube shank assembly can then be removed as a group, using needle-nose pliers if necessary to initially loosen the tube shank from the body. The trigger (50-019) and back lever (50-042) can also be removed at this time.

If further disassembly of the tube shank assembly is needed, start by removing the needle chuck from the needle tube (51-043). This will allow the needle tube to slide out of the *front* of the tube shank. The needle tube spring (50-044) can be removed from the tube shank by unscrewing the spring screw from the end of the tube shank.

**Reassembly is essentially the reverse.** When placing the needle tube into the tube shank, notice how the flat side of the needle tube must line up to fit into the “D” shaped hole in the front of the tube shank. To re-install the trigger and back lever, place the back lever into the slot on the top of the airbrush body (see photograph 3), and move it forward. *Make sure that the bend of the back lever is directed towards the rear of the airbrush.*

The tube shank assembly may now be screwed into the airbrush body. To install the trigger, pull the back lever towards the rear of the airbrush and insert the trigger so that it is seated properly within the air valve.

# MODEL 155™ Anthem™ AIRBRUSH

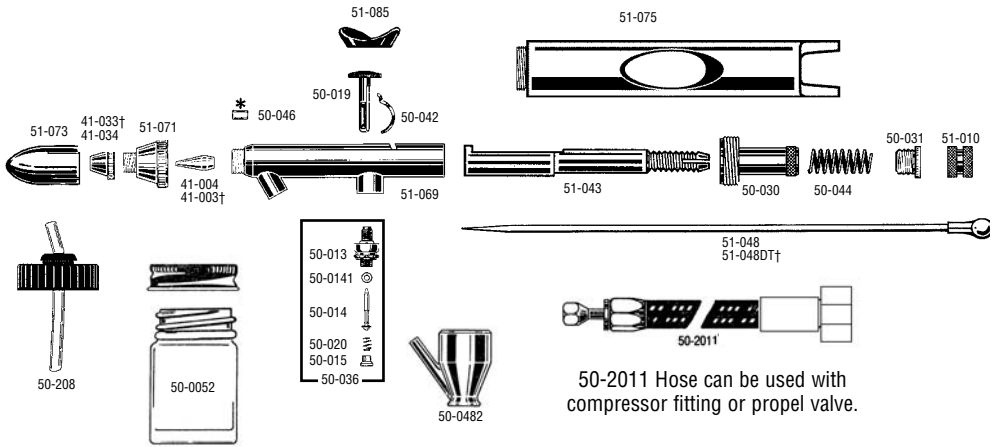

50-2011 Hose can be used with compressor fitting or propel valve.

†Adaptable Hybrid airbrush parts

\*The PTFE Needle Bearing carries a lifetime warranty and free replacement at the factory only.

## EXERCISE ONE/FREE HAND CONTROLLED EFFECT



FIG. 1



FIG. 2

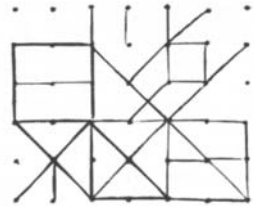

FIG. 3

The exercise shown in fig. 1 is accomplished by practicing the triggering technique explained on page 3. Pull back slightly on the trigger, while air is on, to create a fine line. Approximately half way through your stroke motion push trigger forward to discontinue paint flow. While continuing your stroke motion slightly pull trigger back again to re-create your fine line pattern. This exercise will enable you to draw straight lines without forming dots or puddles at the beginning and end of each line. Fig. 2 is parallel line graduating from narrow to broad. These are made by releasing more color and at the same time, lifting the airbrush away from the surface. Practice daily to develop trigger action control. Fig. 3, layout in pencil 1/2 inch squares. Airbrush the dots as small as possible and connect dots with straight lines of even tone. Practice every lesson carefully before proceeding to the next one.

## EXERCISE TWO

On a board or paper, lightly pencil in a number of 1/2 inch squares. Hold the airbrush about 1/2 inch from the surface and spray small dots on the intersecting lines, as shown in fig. 4. When you are able to place the dots accurately, begin enlarging the size of the dots (fig. 5) by allowing more color to flow through the airbrush. At the same time increase the distance between the airbrush and the paper or board. If the airbrush is held too closely to the paper with the trigger pulled all the way back and down, "puddles" will form and spread. Aim for accuracy not speed and continue practicing until you can spray any size dot exactly where you want it. This simple lesson will give you control of position and density of dots or shapes you require, which are important for touch-ups and fill-in work.



FIG. 4



FIG. 5

## MASKING OFF

In the next several exercises you will need to mask off a square area. Make a mask from 4 pieces of scrap paper (fig. 8). These masks are held in place by masking tape, keeping the atomized material from creeping into the margins around the area. When using masks spray over the edge.

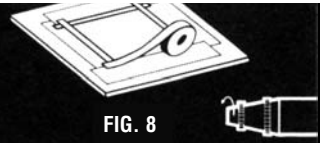

FIG. 8

## EXERCISE THREE/EVEN TONES

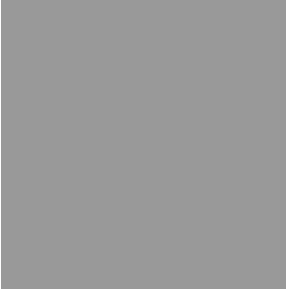

FIG. 9



FIG. 10

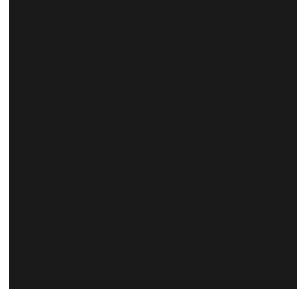

FIG. 11

To accomplish a flat tone, we will airbrush a fine consistency of paint from left to right at the top of the taped area. Hold the airbrush about four inches from the surface of the sheet. Be sure to spray a portion of the tape so that no light line shows when the masking tape is removed. Use the trigger technique on page 3 throughout this lesson. Now airbrush from right to left, overlapping the previously airbrushed strokes. Continue down the entire sheet, trying not to create a line pattern with the airbrush. Overspray the tape, both right and left and top and bottom. Begin at the top again and spray the entire page. Repeat the exercise until you reach the desired smooth coverage of the entire area. Do not attempt to cover the entire sheet with a heavy tone at one time. Build the tone gradually (figs. 9-11). Make sure the work and tape are dry before removing the masking tape. This should be done carefully to avoid tearing the surface of the paper it is adhered to. If your first results are not satisfactory, repeat the lesson until you are satisfied.

## EXERCISE FOUR/VARYING SHADES

This lesson is similar to the previous one. This time you will start at the top and gradually fade into white (fig. 12). Do not fade abruptly and do not carry the tone further than 2/3 or 3/4 of the page. Remember, you must stop your tone shorter each time, since the overspray will build up. Fig. 13 is a combination of masking and varying shades. The important thing in this exercise is to train your eye so that all the small squares have the same tone value.



FIG. 12

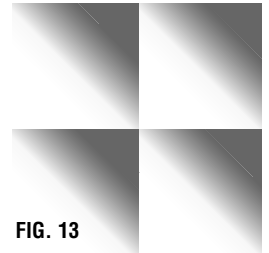

FIG. 13

## TECHNIQUES TO USE

Masking or frisket is used mostly to create a sharp edge or when more than one color is applied. A new frisket is cut for each color and covers any area that should not be sprayed. Badger's Foto/Frisket™ Film is specially formulated for use on all surfaces commonly used for airbrushing.



A flat surface mask can be cut from Foto/Frisket™ Film. For a sharp edge, hold the mask flat in position. For a softer edge, elevate the mask slightly by resting on a ruler or other flat object.

For contour masking (models, ceramics, etc.) liquid frisket is recommended.

## STENCILS/TEMPLATES

Stencils/templates are used when a design needs to be duplicated, as in posters and decorating. Cut from stiff paper, FOTO/FRISKET™ FILM or NO-TACK Stencil Film, hold the stencil firmly in position and spray starting with the edges and work inward. A reverse (negative) stencil can also be used, spray along the stencil edge.



POSITIVE



REVERSE (negative)

## EXERCISE FIVE/THREE DIMENSIONAL EFFECTS USING MASKS OR FRISKET

Rendering these basic forms will provide instruction and sequence in shading and tone gradiation created with airbrush for three dimensional effect and realism. In airbrushing these shapes, it is a general rule to have the light source coming from the upper left hand corner at about a 45 degree angle.

**SPHERE** Place a frisket on the board making sure the remaining portion of the board is not exposed to airbrushing overspray. Use a compass knife and cut your circle and remove. Gradually airbrush lightly around the entire edge of the circle in a curved, rocking, back and forth motion. Next, start from the bottom right hand portion of the circle and airbrush upwards towards the center not quite reaching the center. Allow a highlighted circular portion of the sphere near the upper left hand portion. Continue until the sphere takes on a three dimensional appearance.



**CUBE** Make a line drawing lightly about twice the size of the above illustration. Cut a frisket for the outline and dividing lines of the separate sides. At this time remove the frisket from the side farthest from the light source (lower right). Gradually airbrush a tone from the upper left corner to the lower right hand corner. Repeat the gradual dark tone as necessary, then remask the finished side and start the other sides until the desired effect is achieved.



**CYLINDER** Note how the light varies on the cylinder and makes the top flat surface different from the curved area. The frisket is cut along the curved line and while the top is masked, the side is sprayed. Then the side is masked and the top is sprayed. Only practice will enable you to know how dark to paint one side of the subject while the other is masked.

## TROUBLESHOOTING YOUR AIRBRUSH

- 1) Grainy spray.** Caused by paint being too thick. Add thinner sparingly to the mixture and check the needle and regulator tip for dried paint. Also check the air supply to make sure airbrush is being operated at the proper pressure.
- 2) Buckling paper.** Paint may be too thin or you may be applying paint in too heavy a coat.
- 3) Paint blobs at the ends of the stroke.** You are spraying paint before moving your hand and stopping the movements before shutting off the paint flow.
- 4) Flared ends.** Caused by turning the wrist while airbrushing. The whole forearm should move evenly across the paper.
- 5) Centipedes.** Caused by spraying too much paint too close to the paper. If a fine line is desired, lightly pull back on the front trigger.
- 6) Splattering.** Caused by permitting the needle to snap back into tip. Always release the trigger gently. Check for dried paint on needle or tip. Also may be caused by triggering, see page 3 for proper triggering.
- 7) Curved stroke.** Caused by arcing arm too close to the paper. Arm should always be parallel to the work, unless this

effect is desired.

**8) Bubbles through the color cup.** The spray regulator might be turned out too far, or the head may be loose. Check both and tighten if necessary.

**9) Color spray cannot be shut off.** Tip may be clogged. This is recognized by a "spongy" feel when needle is set into tip. Remove the head from the airbrush and clean the tip – see Maintenance and Cleaning, page 3.

**10) Pulsating.** This is caused by the head being loose or the tip not seated properly. See page 3, Replacing the Tip.

*The only other reason that the airbrush may begin to pulsate is if the needle bearing wears down or falls out. There is a life-time warranty on this part because the owner cannot replace this part. If this occurs send back to factory for no-charge service (see warranty page 2).*

#### PLEASE READ CAREFULLY BEFORE USING YOUR BADGER AIR-BRUSH

Your new BADGER airbrush should provide you with many hours of enjoyment. However, because of the nature of airbrushing and of the composition of materials which you may use in your airbrush, we are providing you with information about potential hazards.

Many materials commonly used in arts and crafts projects (such as lacquers, varnishes, adhesives, fixatives, powders, acrylics and solvents) can be extremely hazardous. Not all of these materials will be used in your airbrush, but may be used in some other phase of your project. We recommend that you always find out what is in the material you use. We suggest that when using **any** chemical substance that you request a copy of the manufacturer's **Material Safety Data Sheet** from your art supply dealer. This will give you some indication of the dangers posed and some of the precautions you need to take.

#### ALWAYS READ AND FOLLOW LABEL DIRECTIONS CAREFULLY.

**CHILDREN** Hazardous materials pose an even greater risk to children due to their lesser body weight and frequent lack of care in following directions. CHILDREN SHOULD ALWAYS BE SUPERVISED WHEN USING AN AIRBRUSH OR ART MATERIALS (unless the materials have been certified by the Crayon, Watercolor and Craft Institute). An airbrush is not a toy. It should not be pointed at anyone or at oneself.

#### GOOD HYGIENE IS IMPORTANT ANYTIME YOU ARE WORKING WITH ART MATERIALS.

- Do not smoke, eat or drink while airbrushing.
- Avoid putting your fingers in your mouth while working on art projects.
- Be sure to clean your fingernails and wash your hands when you are finished.
- Be especially careful of the materials you use if you have cuts or open sores.
- STOP WORK AT THE FIRST SIGN OF DIZZINESS, NAUSEA, HEADACHE, BLURRED VISION, OR SKIN IRRITATION. Seek fresh air immediately, and call a doctor if the symptoms persist or are severe.

**VENTILATION** An open window does **not** provide adequate ventilation when working with hazardous art materials. When working with these materials, you should have an exhaust ventilation system (one which removes vapors, dusts, etc., from the area in which you are working and vents to the outside). A general ventilating system dilutes toxic vapors with fresh air to lower their concentration to a safer level.

Many factors have to be considered to determine the kind of ventilating system you should have. We suggest that you contact the National Institute for Occupational Safety & Health, (NIOSH), Robert A. Taft Laboratories, 4676 Columbia Parkway, Cincinnati, Ohio 45226 for publications which they have dealing with ventilating systems.

**RESPIRATORS** A respirator may pose more of a hazard than a help unless:

- you get one designed to filter out the specific hazardous substance you are working with
- one that fits properly
- you keep it properly cleaned and maintained.

We suggest you buy only a NIOSH\* approved respirator and read and follow carefully the instructions which come with it.

A respirator may not be suitable for some people with heart or breathing problems. Information on respirators is also available from NIOSH at the address above.

**RESOURCES** In addition to NIOSH, you might want to read **Health Hazards Manual for Artists** by Michael McCann, PhD (published by the Foundation for the Community of Artists, 280 Broadway, Suite 412, New York, New York 10007) or contact the Consumer Products Safety Commission, Washington, D.C. 20207.

BA327 Made and Printed in U.S.A. 10/05

© BACo.2005



**BADGER AIR-BRUSH CO.**

9128 W. BELMONT AVE • FRANKLIN PARK, IL 60131

[www.badgerairbrush.com](http://www.badgerairbrush.com)

**iHOBBYEXPO**

